

EPM50 Series

Diameter ϕ 50mm Shaft type Absolute Multi-turn Rotary Encoder

Radial cable type

Line-up

■ Features

- Compact size of diameter ϕ 50mm
- Parallel data / SSI data transmission type
- **Total 23bit resolution(8388608 divisions) of 10bit single-turn(1024 divisions) and 13bit multi-turn (8192 divisions)**
- Easy zero adjustment using single-turn / multi-turn data separated reset function
- Memorizing revolution data up to $\pm 90^\circ$ after blackout without memory back up function
- Possible CW/CCW direction setting with direction function
- Maximizing users convenience with lclear, overflow alarm (OVF) function
- Protection structure IP64(IEC standard)
- Provides Latch function(Parallel output model only)



Radial cable type



Axial cable type

■ Applications

- Precision machine tool, Fabric machinery, Robot, Parking system

⚠ Please read "Caution for your safety" in operation manual before using.



■ Ordering information

EPM50S	8	-	10	-	13	-	B	-	PN	-	24	-	
Series	Shaft diameter	Single-turn	Multi-turn	Output code	Control output	Power supply	Cable						
Diameter ϕ 50mm	ϕ 8mm	10bit (1024 division)	13bit (8192 revolution)	Binary Code	PN: Parallel NPN open collector output S: SSI	12-24VDC \pm 5%	No mark: Axial cable type S: Radial cable type						

■ Specifications

Type		ϕ 50mm Multi-turn absolute encoder		
Model		EPM50S8-1013-B-S-24	EPM50S8-1013-B-PN-24	
Resolution	Single-turn	1024 division(10Bit)		
	Multi-turn	8192 revolution(13Bit)		
Rotation limit when power is off ^{※1}		$\pm 90^\circ$		
Electrical specification	Output	Output code	24bit, Binary 2 code	Binary 2 code
		Output Interface	SSI(Synchronous Serial Interface)	Parallel
		Output type	Line driver	NPN open collector output
		Output signal	Single-turn data, Multi-turn count, OVF alarm ^{※2}	
		Line driver output	• Low: Sink current - max. 20mA, Residual voltage - max. 0.5VDC • High: Sink current - max. -20mA, Output voltage - max. 2.5VDC	
		NPN open collector output	Sink current : Max. 32mA, Residual voltage : Max. 1VDC	
	Logic	Negative logic output		
	Response time	Max. 1 μ s (Cable: 2m, I sink = 32mA)		
	Input	Input signal	Single-turn data reset ^{※3} , Multi-turn count reset ^{※4} , Direction, Clear	
		Input level	High : 5-24VDC, Low : 0-1.2VDC	
Input logic		Low active ^{※5} , HIGH or OPEN for common use		
Input time		Direction : Over 100ms		
		Single-turn data reset : Over 100ms		
		Multi-turn count reset : Over 100ms		
	Clear : Over 100ms			
SSI Clock Input Frequency	100kHz to 1MHz	Latch : Over 500 μ s		

※1: It calibrates the multi-turn counts by comparing single-turn data before/after power off without counting multi-turn counts when power is off. It shall be used on the condition that no over-rated revolution occurred since proper multi-turn data may not be available if any revolutions occurred over $\pm 90^\circ$ from the position when power is off.

※2: OVF alarm is ON when multi-turn count is out of counting range (0 to 8191 revolution). It shall be initialized by changing the setting of direction or applying multi-turn count reset or clear signals.

※3: Single-turn data shall be initialized as 「0」 when single-turn data reset is input.

※4: Multi-turn count shall be initialized as 「0 revolution」 when multi-turn count reset is input.

※5: High active is customizable.

ø50mm Shaft Multi-turn Absolute type

Specifications

Type	ø50mm Multi-turn absolute encoder		
Model	EPM50S8-1013-B-S-24	EPM50S8-1013-B-PN-24	
Electrical specification	Max. Response frequency	50kHz	
	Power supply	12-24VDC, ±5%(Ripple P-P : Max. 5%)	
	Current consumption	Max. 150mA(Disconnection of the load)	Max. 100mA(Disconnection of the load)
	Insulation resistance	Min. 100MΩ(at 500VDC between all terminals and case)	
	Dielectric strength	750VAC 50/60Hz for 1 minute(Between all terminals and case)	
	Connection	Cable type(Cable gland)	
Mechanical specification	Starting torque	Max. 40gf·cm(0.004N·m)	
	Moment of inertia	Max. 40g·cm ² (4×10 ⁻⁶ kg·m ²)	
	Shaft loading	Radial : 10kgf, Thrust : 2.5kgf	
	Max. revolution ^{*6}	3000rpm	
Vibration	1.5mm amplitude or 300m/s ² at frequency of 10 to 55Hz(for 1 min.) in each of X, Y, Z directions for 2 hours		
Shock	Approx. Max. 50G		
Environment	Ambient temperature	-10 to 70°C, storage : -25 to 85°C	
	Ambient humidity	35 to 85%RH, storage : 35 to 90%RH	
Protection	IP64(IEC standard), Radial cable type : IP50(IEC standard)		
Cable	ø6, 10-wire, Length : 2m, Shield cable (AWG28, Core diameter : 0.08mm, Number of cores : 19, Insulation out diameter : ø0.8)	ø6, 17-wire×2, Length : 2m, Shield cable (AWG28, Core diameter : 0.08mm, Number of cores : 17, Insulation out diameter : ø0.8)	
Accessory	Mounting bracket, Coupling		
Approval	CE		
Unit weight	Approx. 322g	Approx. 475g	

*6: Make sure that. Max response revolution should be lower than or equal to max. allowable revolution when selecting the resolution.

$$[\text{Max. response revolution}(\text{rpm})] = \frac{\text{Max. response frequency}}{\text{Resolution}} \times 60 \text{ sec}$$

*Environment resistance is rated at no freezing or condensation.

Synchronous serial interface(SSl) Output Timing diagram

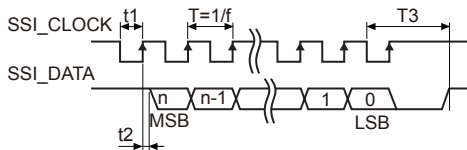

Clock Frequency f	100kHz to 1MHz
T	T : 1 to 10μs
Time lag t2	t2 < 0.3μs
Monoflop Time t3	15μs < t3 < 30μs

Synchronous serial interface(SSl) Data Output

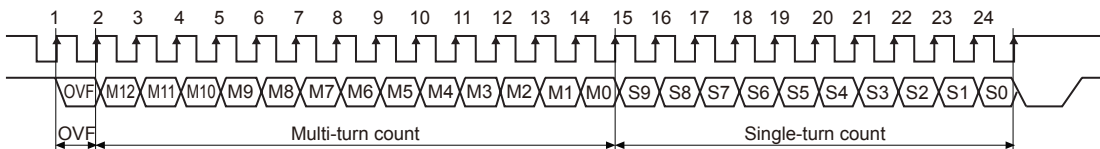

Clock input bit	Data output name	Data output bit	Clock input bit	Data output name	Data output bit
1	Over flow error bit	0 bit	15	Single-turn data	9 bit(MSB)
2	Multi-turn count	12 bit(MSB)	16		8 bit
3		11 bit	17		7 bit
4		10 bit	18		6 bit
5		9 bit	19		5 bit
6		8 bit	20		4 bit
7		7 bit	21		3 bit
8		6 bit	22		2 bit
9		5 bit	23		1 bit
10		4 bit	24		0 bit(LSB)
11		3 bit			
12		2 bit			
13		1 bit			
14	0 bit(LSB)				

- (A) Photo electric sensor
- (B) Fiber optic sensor
- (C) Door/Area sensor
- (D) Proximity sensor
- (E) Pressure sensor
- (F) Rotary encoder
- (G) Connector/Socket
- (H) Temp. controller
- (I) SSR/Power controller
- (J) Counter
- (K) Timer
- (L) Panel meter
- (M) Tacho/Speed/Pulse meter
- (N) Display unit
- (O) Sensor controller
- (P) Switching mode power supply
- (Q) Stepper motor& Driver&Controller
- (R) Graphic/Logic panel
- (S) Field network device
- (T) Software
- (U) Other

EPM50 Series

Parallel Interface 1024 division single-turn data output waveform (Binary code)

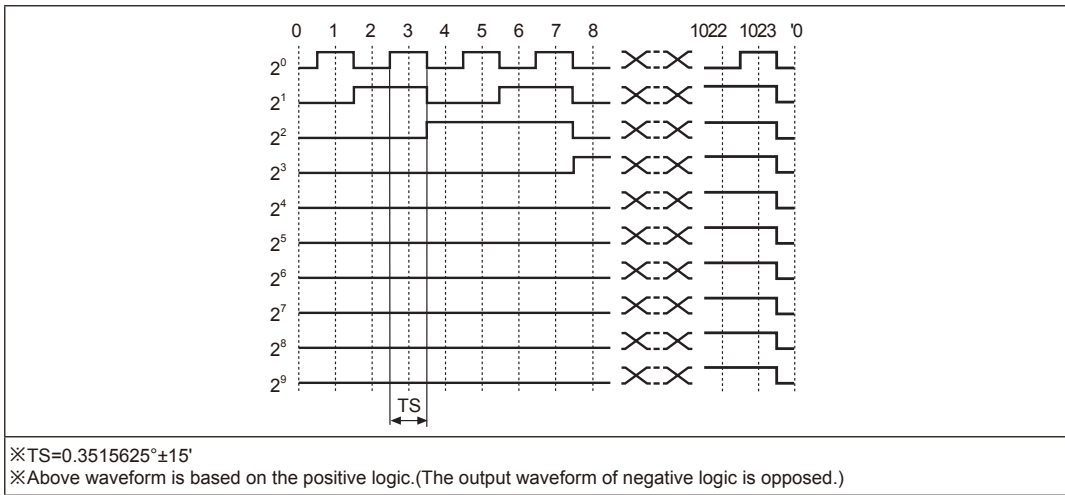

Parallel Interface 8192 revolution multi-turn count data output waveform (Binary code)

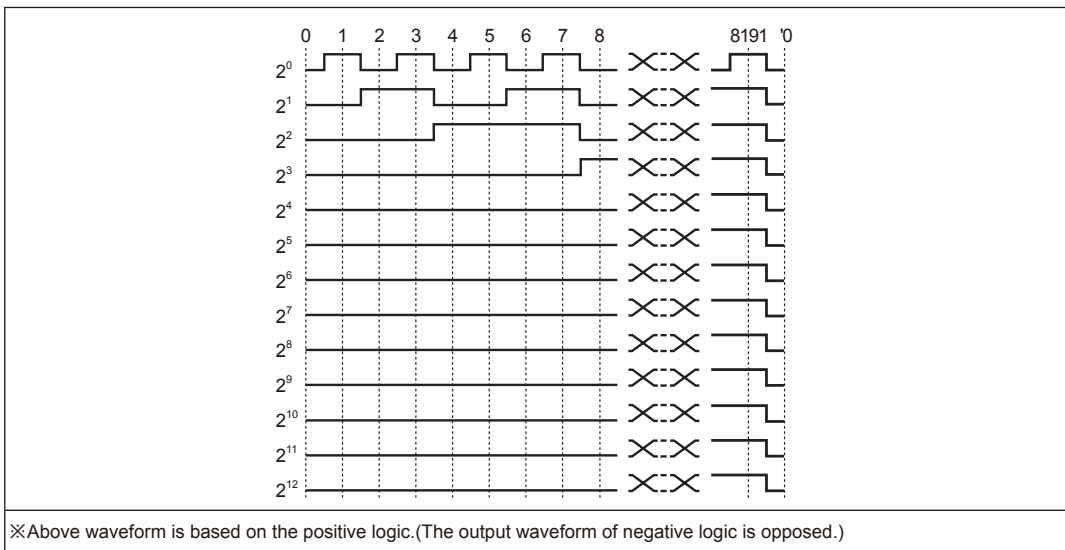

Control output I/O circuit

• SSI input

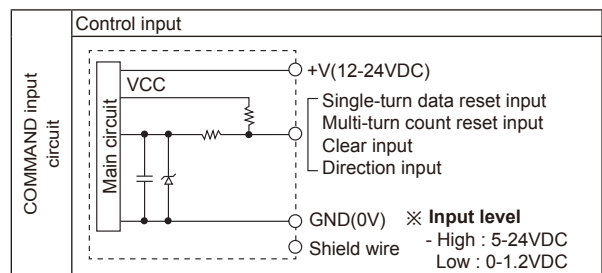
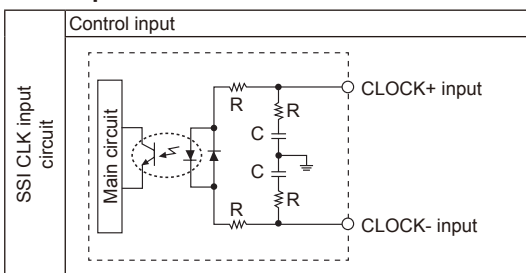

ø50mm Shaft Multi-turn Absolute type

■ Control output I/O circuit

● SSI output

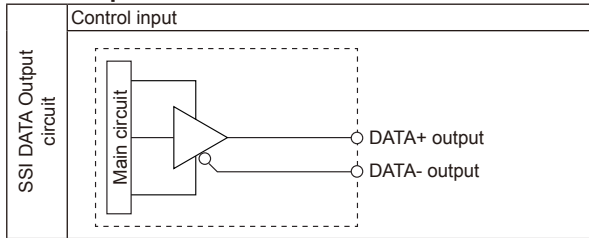

● Parallel input • output

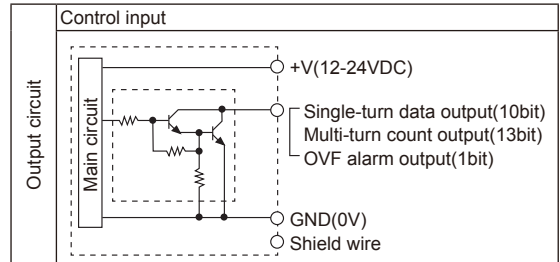
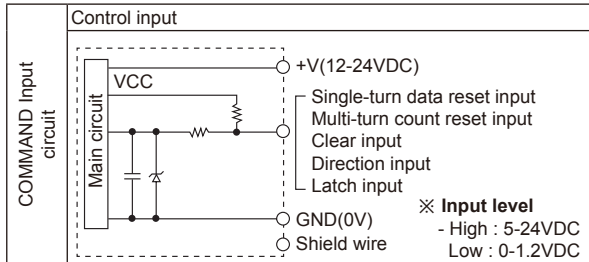

※Output of each bit is the same circuit.

※Overload or short may cause circuit break.

■ Connections

● SSI output

Cable			
Cable color	Description	Cable color	Description
Brown	CLOCK+	Gray	Single-turn data reset
Red	CLOCK-	Blue	Multi-turn count reset
Orange	DATA+	Purple	Clear
Yellow	DATA-	Green	Direction
White	+V(12-24VDC)		
Black	GND(0V)		
Shield wire	Signal shield cable(F.G.)		

● Parallel output

Multi-turn count cable(Sheath color : Black)		
Cable color	Description	
Brown	Multi-turn count	2 ⁰
Red		2 ¹
Orange		2 ²
Yellow		2 ³
Green		2 ⁴
Blue		2 ⁵
Purple		2 ⁶
Gray		2 ⁷
Pink		2 ⁸
Clear		2 ⁹
Light brown		2 ¹⁰
Light yellow		2 ¹¹
Light green	2 ¹²	
Light blue	OVF	
Light purple	Multi-turn count reset	
White	+V(12-24VDC)	
Black	GND(0V)	
Shield wire	Signal shield cable(F.G.)	

Single-turn data cable(Sheath color : Gray)		
Cable color	Description	
Brown	Single-turn data	2 ⁰
Red		2 ¹
Orange		2 ²
Yellow		2 ³
Green		2 ⁴
Blue		2 ⁵
Purple		2 ⁶
Gray		2 ⁷
Pink		2 ⁸
Clear		2 ⁹
Light brown	NC	
Light yellow	Direction	
Light green	Latch	
Light blue	Clear	
Light purple	Single-turn data reset	
White	+V(12-24VDC)	
Black	GND(0V)	
Shield wire	Signal shield cable(F.G.)	

※Please wire properly.

※As for parallel output, it is recommended to connect +V and GND of both multi-turn count cable and single-turn data cable.

※The metal case and shield wire of encoder should be grounded (F.G.).

※Input/Output cable must not be short-circuited, because Driver IC is used in output circuit.

(A) Photo electric sensor

(B) Fiber optic sensor

(C) Door/Area sensor

(D) Proximity sensor

(E) Pressure sensor

(F) Rotary encoder

(G) Connector/Socket

(H) Temp. controller

(I) SSR/ Power controller

(J) Counter

(K) Timer

(L) Panel meter

(M) Tacho/ Speed/ Pulse meter

(N) Display unit

(O) Sensor controller

(P) Switching mode power supply

(Q) Stepper motor& Driver&Controller

(R) Graphic/ Logic panel

(S) Field network device

(T) Software

(U) Other

EPM50 Series

■ Dimensions

(unit: mm)

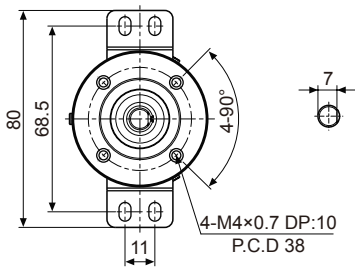

● Bracket

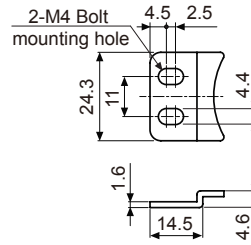

● Coupling(EPM50)

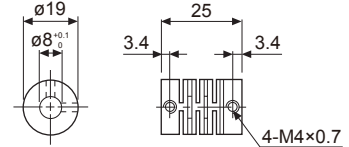

- Parallel misalignment: Max. 0.25mm
- Angular misalignment: Max. 5°
- End-play: Max. 0.5mm

● SSI output

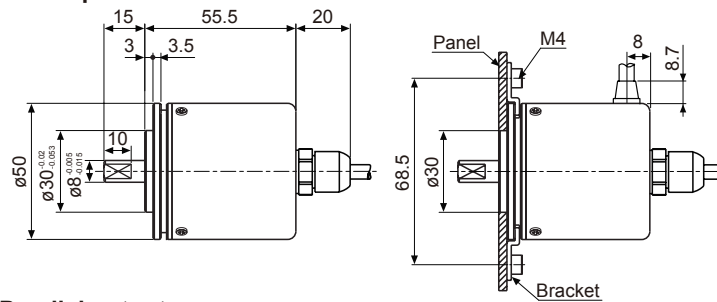

※For parallel misalignment, angular misalignment, end-play terms, refer to the F-78 page.

※For flexible coupling(ERB Series) information, refer to the F-71 page.

● Parallel output

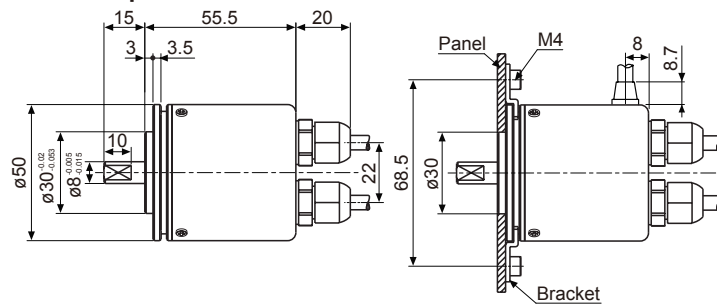

■ Functions

◎ Single-turn data reset

Single-turn data will be initialized as 「0」 when GND(low level) is input over 100ms on single-turn data reset line. In case of not using single-turn data reset line, connect the line to OPEN or +V (High level).

◎ Multi-turn count reset

Multi-turn data will be initialized as 「revolution 0」 when GND(Low level) is input over 100ms on multi-count reset line. In case of not using multi-turn count reset line, connect the line to OPEN or + V (High level). OVF alarm will be initialized with multi-turn count reset input.

◎ Clear

Single-turn data will be initialized as 「0」 and multi-count will be also initialized as 「revolution 0」 when GND (Low level) is input over 100ms on Clear line. In case of not using clear line, connect the line to OPEN or + V (High level). OVF alarm will be initialized with clear input.

◎ Direction

Connect Direction line to OPEN or +V (High level) and turn on the power. Output will increase when rotation direction is CW from shaft axis. In case of connecting to GND(Low level), output will increase when rotation direction is CCW. If direction setting is reset, single-turn data, multi-turn count and OVF will be reset together since direction setting is initial setting which is set with Power ON.

◎ Latch(Parallel output model only)

When connecting latch line to GND(Low level) over 500μs, outputs for single-turn data, multi-turn count and OVF at latch point will be remained. When latch line is connected to OPEN or +V (High level), output will be returned to operating mode output.

◎ Overflow alarm(OVF)

It is an alarm function providing output when multi-turn count is out of rotation ranges(0 to 8191 revolutions). OVF will be initialized through direction setting change, multi-turn count reset or clear input.